

# **WISereader N516**

**E-Book Reader**

**User Manual**

## **Contents**

Quick Guide .....	4
Device buttons.....	4
Using skills.....	7
Basic Operations.....	9
Recent reading.....	9
Bookcase .....	10
Music.....	13
Play Record.....	13
System Settings.....	13
User's Guide.....	15
Other operations .....	16
Player and Recorder .....	16
Battery charging.....	17
File Management.....	18
Browsing pictures.....	19
Adobe reader instruction .....	21
Format .....	21
DRM .....	21
Steps of setting up DRM .....	21
Appendix .....	23

---

Technology Specification .....	23
Caution .....	23
Product maintenance .....	24

## Quick Guide

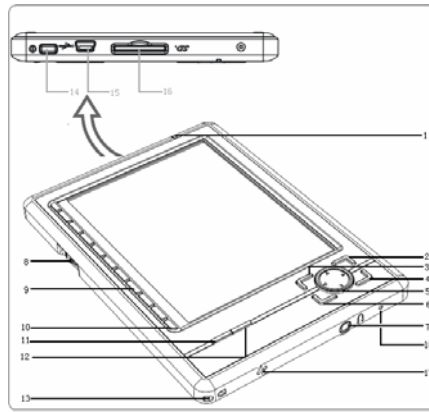

### **Device buttons**

#### ① LED indicator

The red indicator will light when the device is charging, and the blue indicator will light when you are operating the device.

#### ② OK button

- Press this button to confirm when hint information popping up.
- Keep pressing "OK" button over 3 seconds, the

keyboard will be locked, keep pressing this key again, the keyboard will be unlocked.

③ MENU button

Press MENU button to return to the main interface.

④ Play and record button

Open or close the "Player and Recorder" window.

⑤  Direction buttons

Include up, down, right and left side four direction buttons.

⑥ C button

Press C button, cancel the operation and return to the previous interface.

⑦ Earphone outlet

Earphone outlet is located at the end surface of device. Plug in/out earphone here.

⑧ Track wheel

Track wheel is located at the left side of device; pull it up or down to turn page up or down.

⑨ 0~9 number button

- Press any number button to select and operate

the corresponding function at the right side.

- Under the reading status, press the number button 0~9 can jump to the corresponding page directly.

⑩ Bookmark button

Under the reading status, press Bookmark button to enter the "Bookmark" interface.

⑪  Format switch button

Under the reading status, press this button to switch the display format between portrait and landscape.

⑫  Zoom button

Press this button to zoom in or out the characters or pictures.

⑬ String hole

⑭ Power button

Press this button to turn on or turn off the device.

⑮ Mini USB port

USB connection port, it is used for charging the device or transmitting data from PC.

⑯ SD card slot

Insert SD storage card into it.

- ⑰ Speaker
- ⑱ MIC: Microphone
- ⑲ RESET

It's located at the back of device. Click the "RESET" hole when the device is crash or freeze.

### **Using skills**

1. Language option: Before reading books, please select the corresponding language in "Settings", otherwise, the contents would display in unrecognizable code.
2. Books management: You could copy books from PC to device through the USB data wire, but please ensure to save different books into the different language folders.
3. Under the reading status, keep pulling up or down the track wheel located at the side of device for 3 seconds, the book will turn 10 pages up or down at once.
4. Under the reading status, press any number button can jump to the corresponding page directly.

5. Supported Format: TXT, HTML, PDF, EPUB, DOC, JPG, GIF, PNG, MP3.
6. Under the reading mode, please press OK button to refresh the screen compulsively if the display is not clear.
7. Charging: the device can be charged through USB data wire or charger (selective accessory).

## Basic Operations

### ***Main interface***

Turn on the device; the main menu will display automatically. Select corresponding option by pressing the number buttons or pressing the direction buttons and OK button to enter the sub-menu.

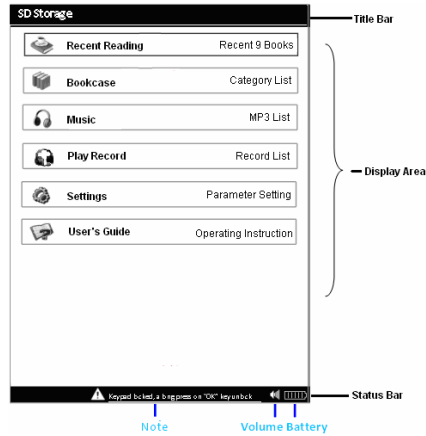

### **Recent reading**

The latest 9 books will be displayed. Press ▲/▼ button to select a book and press OK to confirm, or press the number button to open a book directly. The page you

close last time will be displayed when you open this book.

**Note:** *If one of the books you read is deleted in the SD card, the reading record will still be remained in the "Recent reading" list, but it cannot be opened.*

### **Bookcase**

Bookcase and file quantity will be listed after entering this menu. Select sorted bookcase by moving direction button ▲ or ▼. Enter the next page by pressing ▼ button when the cursor reaching the last item.

Select one bookcase, then press OK button or press the corresponding number button directly to open it, the books' names (display no more than 26 letters) and their sizes will display on the screen respectively.

Select one book, and then press OK to confirm or press the corresponding number button to open the selected book directly.

**Note:** *Before reading books, please select the corresponding language in "Settings", otherwise, the contents would be displayed in unrecognizable code.*

### 1. **Format switch**

Under the reading status, press  format switch button to switch the display format between portrait and landscape. After changing the format, the page number and the total page number would change.

### 2. **Font zoom**

Under the reading status, press  zoom button to adjust the font size in 3 levels.

### 3. **Page turning and jumping**

Page turning: Under the reading status, pull up or down the track wheel to turn page up or down.

Page jumping: Under the reading status, press the number button (you can also input the combined number), and then press “OK” to confirm, the book will jump to the corresponding page directly. Press “C” to delete the number you’ve input, when you cancel all of the numbers you’ve input, the system will return to the reading status.

**Note:** *If the number you’ve input is more than the total page number, the system won’t accept this operation. Keep pulling the track wheel up or down for 3 seconds, 10 pages up or down once, this function can’t be used in*

*image file.*

#### **4. Bookmark function**

**Add a bookmark:** Under the reading status, press “Bookmark” button to enter the bookmark directory, select “Add a bookmark”, and press OK, or press “Bookmark” button again, to add a bookmark in the current page, after that, the system will return to the reading interface automatically.

**Check Bookmark:** Enter the bookmark directory again, a new bookmark record is added under the “Add a bookmark”. The bookmark number and the first 10 characters in the first line in the corresponding page will be shown.

**Use bookmark:** Press the direction button to select a bookmark, then press OK to enter the corresponding page or press the number button to enter directly.

**Note:** *The bookmarks added recently will be shown by date order, only the recent 8 bookmarks can be shown.*

*Bookmark cannot be used in the HTML and image files.*

#### **5. Supported formats**

Support following format: TXT, HTML, PDF, EPUB, DOC.

### **Music**

If there are some music files which the formats are MP3 existed in “Music” folder, Select “Music” in the main menu, then press the direction buttons or number button to select music.

### **Play Record**

If there are some music files which the formats are MP3 existed in “Recorder” folder, Select “Play record” in the main Menu, then press the direction buttons or number button to select a record to play.

**Note:** *The MP3 music files must be saved in “Music” folder. The record format is MP3; they will be saved in the “Recorder” folder automatically. Only the record file which the length is over 10 seconds can be saved.*

### **System Settings**

#### ***Language option***

Enter the “Settings” menu, select “Language option”. Press ▲ or ▼ button to select language, and then press OK to confirm. After that, the window will close automatically.

**Display mode**

There are two display modes, “Sectional Refresh” and “Total Refresh”. Press ▲ or ▼ to select the options, and then press OK to confirm. After that, the window will close automatically.

**Note:** *Sectional refresh: improve the refresh speed, but there will be a few remnant shadows. Total refresh: avoid displaying remnant shadows, the whole screen will flash. Under the sunlight or low temperature, the “Total Refresh” is recommended.*

**Storage Inquiry:** Inquire the free and total memory of SD card.

**Product information:** Display the version information of software and hardware.

**Factory settings:** Restore device to the default settings, the user files will not be influenced.

**Device ID :** We could support after-sale services

according to the device ID, and you also can gain more legal E-books and reading authority.

**Software update** : Connect the device to PC and download the update package from PC, decompress the package and save it under the root directory in SD card, select “Software update”, the system will operate the software updating automatically. (Be careful to operate this function, and please refer to the attentions in appendix)

### **User's Guide**

Select “User's Guide” in the main Menu, the “User's Guide” document will be opened.

## Other operations

### **Player and Recorder**

When you press ▶/■ button or open any MP3 file, the interface of “Player and Recorder” will display.

“▶Play” or “⏸Pause” is implemented by the number button 1; press this button to play or pause music or record.

“🎙Record” is implemented by the number button 2, you can start to record by pressing this button, and

“🎙Recording” will display, there is a  icon will be shown in the status bar at the same time.

“⏹Stop” is implemented by the number button 3; press this key to stop music or record.

“▶Forwards” and “◀Backwards” are implemented by the number button 4 and 5.

Playing mode, “🔄Cycle” and “🔁Single loop”, is implemented by the number button 6.

Press the direction button ▲ or ▼ for selecting the previous or next MP3 file respectively. Press the direction

button ◀ or ▶ for decreasing or increasing playing volume.

### **Battery charging**

#### **Battery capacity volume**



#### **Battery charging**

When the battery has been used up, please charge the battery. The device can be charged through USB data wire or charger (selective accessory)

There are two ways to charge the battery, power-on charging and power-off charging.

Connect the device to the computer with a USB plug data wire. The red LED indicator will light; the battery icon in the status bar will indicate the battery is charging.

**Note:** *The charging time is about 4 hours. The red LED indicator will be off when charging is finished. It's better to charge the battery when the hint screen disappears, and please ensure the battery is fully charged.*

*This will extend the Lithium battery life.*

## **File Management**

### **Connected to computer**

When the device is power-on, connect it to the computer with the USB data wire. At that moment, the computer will automatically detect a new storage device connecting.

Select "Data transmission", and then press OK button to confirm, the device will enter the connecting status.

**Note:** *The SD card can be taken out from the device and insert it into a compatible card reader. Connect it to the computer USB port; it can be used like a common USB flash driver.*

*The current format of all these electronic books saved in the device is HTXT, they adapt the current device's ID code, and they were encrypted already. Thus, those books can't be read at the other devices and also cannot be opened and edited on PC.*

### **File copying**

**Please do not rename, remove or delete the**

**folders pre-stored in SD card.**

Users can setup new folders and save their downloading or copying books in these folders. They can be deleted, removed, copied and renamed.

Please save the different language books in the different folder respectively. (e.g. the English books should be saved in the English folder).

Please select the safe remove method in PC status bar, and then pull out the USB data wire after coping books to device.

***Note:** If the files are saved under the root directory, these files will be shown at the same level as saved in the sub-bookcase, and only 200 files will be shown in max. All files saved at 4 levels directory can be displayed, if a file is saved under the 5<sup>th</sup> directory, it can't be displayed. The number of files in each folder should be less than 512.*

**Browsing pictures****Picture format**

Support following format: JPG, GIF and PNG.

**Picture size**

The image resolution should be limited under 2000×1500. If the resolution is beyond this range, the hint information “Unreadable” will be displayed.

**Note:** *The zoom function can display the pictures at the actual size or optimized size for looking.*

## **Adobe reader instruction**

### **Format**

Support PDF and EPUB files

### **DRM**

1. Adobe DRM protected PDF and EPUB file is supported only if Adobe Digital Editions 1.5 or later is installed on your computer and your WISereader is connected to the computer.

2. Digital Rights

Displays the following only if a book with DRM is selected.

- a. Full viewable: the entire book can be read
  - b. Restricted: Some or all of the book cannot be read.
3. Expiration date

Displays the expiration date of a book if the book with DRM has an expiration date.

### **Steps of setting up DRM**

Step 1. Install the Adobe Digital Edition on your computer.

Step 2. After installation, open the above software, and

enter your Adobe account (which should be applied at beginning).

Step 3. After turning on the WISereader, (click on “Set DRM” which is included in the “Settings” interface. Please ignore this item if you cannot find it). Then, keep the Adobe Digital Edition open, and connect the WISereader to the computer, there will show a window for activation. Click on “Authorize the device”, then DRM activation is completed.

**Notes:**

- 1. The authorization information is stored in SD card. Thus, you need to active the device again if using a new SD card.*
- 2. After activated, if you want to use a new account to active, please delete the hidden folder under SD root: “.adobe-digital-editions”.*

Please refer to below website for more information.

<http://www.adobe.com/products/digitaleditions>

## Appendix

### **Technology Specification**

Size: 152mm×108mm×12mm

Screen: 5" Electronic Paper Display (EPD); 8-level gray scale; Ratio 4:3; Pixel resolution: 800×600

Storage device: expanded 2GB SD card (32GB in maximum)

Power supply: internal Lithium battery 1500mAh

PC Operation System:

Windows2000/XP/Vista in English, Chinese Simplify, Chinese Traditional.

Operating temperature: 0°C~40°C, 32°F~104°F

Storing temperature: -20°C~55°C, -4°F~113°F

### **Caution**

1. Under the direct sunlight or low-temperature environment, the characters displayed on the screen would be fading, please enter "Settings" interface and select "Total Refresh" to refresh the whole screen.
2. When the device is crash or freeze, click the "RESET"

hole located at the back of device to restart the system.

3. When the power run out and device can not be turned on, please charge the device.

4. If SD card can't be recognized for a long time, you can plug in the SD card again or shut down the device and restart it. When the system is reading data, please do not remove the SD card or reset the system.

5. If SD card need to be formatted, please backup all data in the SD card first, and select FAT-32 format.

6. Please leave at least 10M storage space in the SD card for reading and writing the temporary files in the device.

7. Due to the limitation of memory, some complex PDF files can't be decoded by the device. The hint information:" The file can not be opened" will display.

8. Due to the limitation of display technology, the device can't work fast yet, please avoid continuously operating the device fast.

9. Technology service: [tech@hanvon.com](mailto:tech@hanvon.com).

### **Product maintenance**

#### ***Software upgrade***

Please download the legal upgrade package from Hanvon website. The device need to be connected with PC and ensure SD card is inserted in it. If the upgrading procedure is interrupted, there will be an error in the system. The software upgrading package will be uploaded to [www.hanvon.com](http://www.hanvon.com) regularly.

***Operating environment***

The operating temperature for this device is from 0°C to 40°C (from 32°F to 104°F). The performance will get worse, if the operating temperature extend this range. Please avoid using this device under the direct sunlight, in damp and dust place. In the northern area, please avoid using this device outside in the winter.

***Cautions about battery***

Lithium battery is dangerous. It would cause an explosion if the battery is replaced inappropriately, please definitely sure to replace the same type battery or the compatible battery, and please according to the manufacturer's direction to dispose the used batteries.

***Automatic shutdown***

Under the power-on status, if the device has not

been operated for about 120 minutes, or the battery has been used up, the device will shut down automatically.

**Safety**

Please do not reading during driving or riding.

**Falling prevention**

The parts in this device are friable; please prevent the device from dropping, smashing, bending and high pressure.

**Non waterproof**

The device is non-waterproof, please keep away from water.

**Cleaning**

Please use soft cloth or the other similar material to clean the screen and faceplate, please avoid cleaning with water and cleanser.